

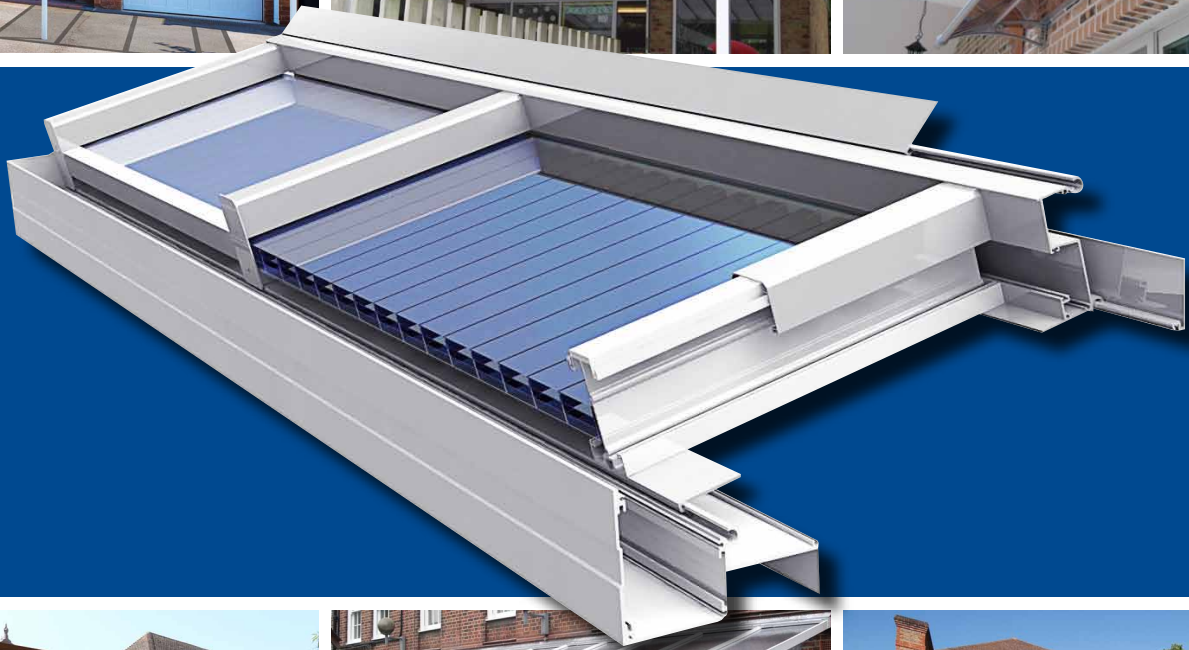

World Class Trade Glazing Systems Delivered Fast

Canopy, Carport & Veranda Solutions



0845 869 6006
www.milwoodgroup.com

ABOUT US



World Class Trade Glazing Systems Delivered Fast

The Milwood Group manufacture and supply the highest quality canopy, carport, and veranda systems to both large and small companies within the Construction sector. With over 25 years of experience within the glazing industry we can provide specialist knowledge to enable you to achieve added value for your company and competitively priced products for your clients.

Our customers include Manufacturers, Retailers, and Installation companies who wish to provide their commercial or domestic customers with high quality, yet cost conscious shade and shelter products. Due to the versatility of our products and their pleasing aesthetics, our structures are also popular with Architects, Designers and Main Contractors.

Our customers are at the heart of our business and we will make it our mission to provide you with everything needed to ensure you can serve your customers easily and effectively. As part of our service we offer easy to follow installation guides, downloadable marketing material for your Sales team and technical drawings for Architects and Designers to make specifying our products simple.

**QUALITY, COST EFFECTIVE SYSTEMS
DISTRIBUTED ACROSS THE UK**





FREE INSTALLATION TRAINING

Become an Approved Milwood Group Installer and create stunning external structures for your clients.

To help ensure our products work perfectly for you every time, we also offer free Installation Training with your first order*, allowing you to become an Approved Milwood Group Installer. We have highly skilled Installation Training Providers who can train your teams at a location anywhere in the UK.

Our Installation Training Providers have personally installed our products for many years, and this hands-on-experience has given them extensive knowledge of our products, enabling them to provide comprehensive and easy-to-follow advice to help you install systems quickly and easily.

We recommend that every new customer undertakes our Installation Training with one of our fully trained operatives to ensure you can install the perfect canopy, carport or veranda for your customers. In addition to this training, we will also supply a comprehensive

Fitter's Pack that includes detailed photos and fitting instructions to guide you through an installation, and a DVD to show you exactly how a system is put together – this can be used as a handy refresher for your team to watch before an installation, or it can be used for future training to additional fitting teams in your organisation.

And what's more all this is FREE with your first order (subject to Terms and Conditions)

In addition to free Installation Training we also provide all our customers with materials to help promote, sell and offer aftercare on all our products - including a comprehensive After Sales Pack to present to your customers on completion of an installation.

If you are interested in distributing our products and would like access to this exclusive material please email us at sales@milwoodgroup.com

**Simplicity 35 and 25 orders only*

THE SIMPLICITY SERIES

Working in partnership with the UK's leading aluminium extrusion specialist, we have created the Simplicity Series, a range of shade and shelter products that are quick and easy to install. Due to their unique design and versatility, these all-aluminium systems have revolutionised the canopy, carport and veranda industry, allowing you to create a multitude of external solutions that provide exceptional weather protection. All products within the Simplicity Series will be sent to you as a complete kit, all you need to do is fit the component parts together and fix the structure securely in the required area.



Simplicity 35

The Simplicity 35 is our most popular product due to its durability, versatility, and unlimited length. It is completely constructed from aluminium, giving you a structure with unbeatable durability together with a life expectancy of up to 25 years. This robust system is also supplied with a full 10 year guarantee.

The Simplicity 35 can be manufactured to any length to meet specific requirements and can span up to 6 metres, enabling you to cover large areas easily with minimum posts. It has a modern, stylish appearance and benefits from robust integral aluminium guttering which creates an attractive finish to the structure whilst also

ensuring quick installation. Furthermore, this aluminium guttering requires minimal subsequent maintenance throughout the product's lifetime. The Simplicity 35 creates effective shelter from the rain and snow and offers high UV protection. It can also help keep the interior of a building cool by shading the windows and preventing unwanted heat and glare.

The Simplicity 35 system features 35mm structured polycarbonate roof panels, which are available in clear or opal and offer up to 99% UV protection. The aluminium framework, supplied in white as standard, can be coloured to any RAL colour to suit your customer's preferences

and we can also offer bespoke Designer Finishes including woodgrain, gold and marble for a stylish and unique finish to the structure.

The Simplicity 35 has passed the ACR(M) 001:2005 Test for Non-Fragility of Profiled Sheeted Roof Assemblies and is certified as a Non-Fragile system (providing the installation conforms to span and loading charts – please contact us for more information). This glazing system must be used in conjunction with Milwood polycarbonate to conform to wind and snow loadings for the UK. For more information visit www.milwoodgroup.com/blockedgepoly

CREATE STYLISH AND FUNCTIONAL COVERED OUTDOOR AREAS



Features & Benefits

- **Full 10 Year Guarantee** and a 25 year Life Expectancy
- **Fully Aluminium System** – Including heavy duty structural aluminium roof bars for ultimate strength
- **Stainless Steel Fixings** – All of the fixings are 316 marine grade stainless steel for longevity and total resistance to corrosion
- **Integral Aluminium Guttering** – Saves time on installation and creates a robust and attractive gutter system
- **35mm Structured Polycarbonate with block edge finish** – A block edge finish features a hard edge on both sides of the panel, which provides a much stronger roof system for improved snow loading capabilities.
- **Fire Performance** - Our polycarbonate panels benefit from excellent fire performance, meeting BS476 part 7 class 1, EN13501 and B-s1, d0
- **Robust Roof System** – The roofing system is strong enough to be walked on as a means of escape and maintenance, with the use of boards
- **High UV Protection** – A layer of UV absorber is coextruded on the outer surface of the roof panels which prevents damaging UV radiation from penetrating the sheet, and protects those underneath from the sun. UV protection also prevents yellowing and loss of strength to the panel - giving it longer life.
- **Wide Range of Colour Options** – The Simplicity 35 can be coloured to any RAL colour, plus a range of Designer Finishes are available, please see page 9 for details
- **Large Projection** – Projection of up to 6 metres to create large shaded areas if required
- **Unlimited Length** – This canopy can be constructed to any length to suit requirements.
- **Victorian Upgrade available** – Add stylish period features to your canopy, perfect for traditional or historical buildings - see page 9 for more details.



Simplicity 35 canopy with Victorian Upgrade

Information on the design load and maximum span limits can be accessed from our website - please contact us for more details.



Wall Beam

The new fully aluminium wall beam is easy to install and will achieve 2.5 degrees to 45 degrees, giving you maximum scope for the height at the back of your canopy.

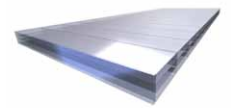

Polycarbonate 35

Our lightweight 35mm polycarbonate roof panels are up to 200 times stronger than glass and 10 times stronger than uPVC panels.



Roof Bar Top Caps

Fully aluminium top caps complete with dual colour coded weather seals.



Roof Bars

Heavy duty structural aluminium roof bars provide the ultimate strength (i value 180).



Integral Guttering

Saves time on installation and is also stronger than an external gutter system.



Flashing Strip

The Flashing Strip attaches to the Eaves Beam to determine the pitch of the canopy.

THE SIMPLICITY SERIES

Simplicity 25

The Simplicity 25 is an aluminium system that features block edged 25mm polycarbonate sheets exclusive to the Milwood Group - these polycarbonate panels have extruded edges which are harder and stronger than any other polycarbonate on the market, allowing for better snow loading capabilities.

This system can be constructed to any length, with fixed projection sizes of 1, 2, 2.5, 3 and 3.5 metres. Due to its streamlined design, it has been created to suit customers who wish to offer the main

features and benefits that a Simplicity 35 system offers, but at a lower price.

The Simplicity 25 has a modern attractive look that complements most building designs. Because of its design, it is particularly popular with customers who are looking to supply stylish domestic carports and verandas.

Please note: The Simplicity 25 roof is classed as a Fragile roof – so requires fragile roof stickers if used in the commercial sector.

This glazing system must be used in conjunction with Milwood Polycarbonate to conform to UK wind and snow loadings.



PROVIDE
EFFECTIVE
COVER FROM THE
ELEMENTS WITH
THE SIMPLICITY 25



Features & Benefits

- **Full 10 Year Guarantee** and a 25 year Life Expectancy
 - **Fully Aluminium System** – Constructed from aluminium with structural aluminium roof bars
 - **Stainless Steel Fixings** – All fixings are 316 marine grade stainless steel for longevity and total resistance to corrosion
 - **Integral Aluminium Guttering** – Saves time on installation and creates an attractive, sleek look which is also stronger than an external gutter system
 - **25mm Structured Polycarbonate Panels with a block edge finish** – For improved snow loading capabilities
 - **Fire Performance** – Our polycarbonate panels benefit from excellent fire performance, meeting BS476 part 7, class 1 and EN 13501 B-S1, d0
 - **High UV Protection** – During the manufacture of our polycarbonate panels, a layer of UV absorber is coextruded on the outer surface, providing high UV protection, this also prevents yellowing and loss of strength to the panel - giving it longer life.
 - **Wide Range of Colour Options** – The Simplicity 25 can be finished to any RAL or BS colour, plus a range of Designer Finishes are available - see page 9.
 - **Unlimited Length** – This canopy can be constructed to any length to suit requirements, with fixed projections of 1, 2, 2.5, 3 or 3.5 metres
 - **Victorian Upgrade available** – Add stylish architectural features to your structure to create an ornate finish perfect for domestic or historical buildings - see page 9 for more details.
- Information on the design load and maximum span limits can be accessed through our website - please contact us for details.**

THE SIMPLICITY SERIES

Simplicity 16

It's simple; the Simplicity 16 has been developed with speed of installation, durability and cost in mind. As our most economical system it allows you to supply a low-cost shade and shelter solution to your clients. It can project up to 3.5 metres and has a lightweight roofing system, which is ideal for creating cost effective carport and veranda structures.

The stylish modern design gives a look that is second to none, enhancing any building's aesthetics. It also offers unbeatable structural performance, simply out performing all other carport and canopy systems pound for pound. This highly versatile canopy and carport system offers a variety of solutions for:

- Carports
- Verandas
- Smoking Shelters
- Walkway Canopies
- Covered Play Areas
- Porch Canopies
- Caravan Shelters
- And many more applications

The Benefits of using this system:

All-aluminium system: The Simplicity 16 is only manufactured from aluminium to offer exceptional longevity and easy maintenance.

Easy installation: We have developed this system in partnership with one of the most prolific extrusion designers in the industry. Through his extensive expertise and using our knowledge gained from 25 years experience, we have created the simplest fixing system possible.

**UNBEATABLE
STRUCTURAL
PERFORMANCE**

Impact resistance: Some of the systems on the market today use PVC or GRP which do not have the impact resistance of polycarbonate. We only use triple wall 16mm polycarbonate sheeting to ensure that your investment lasts and has the impact resistance and the snow loading capabilities for wherever you are in the UK.

Variable Roof Pitch: Unlike the majority of roof kits, which only offer a fixed pitch, the Simplicity 16 offers a pitch range of 2.5 degrees to 22.5 degrees to give you that little bit extra.





Features & Benefits

- **Standard Lengths:** 2.5m, 3m, 3.5m, 4m, 4.5m, 5m, 5.5m, 6m. Please Note: any of the listed lengths can be joined together to create a bespoke length
- **Available Projections:** 1.5m, 2m, 2.5m, 3m, 3.5m
- **Full 10 Year Guarantee** and a 25 year Life Expectancy
- **Simple fixing system with minimal parts** - For quick and easy installation
- **Low profile** - The Simplicity 16 can be fitted in areas where height is restricted
- **Stainless Steel Fixings** - All fixings are 316 marine grade stainless steel
- **Integral Aluminium Guttering** - Saves time on installation and is also stronger than an external gutter system
- **16mm Structured Polycarbonate Panels** - Available in a clear or opal finish
- **High UV Protection** - A layer of UV absorber is coextruded onto our roofing panels to offer high UV protection
- **Wide Range of Colour Options** - The framework can be finished to any RAL colour, plus a range of Designer Finishes are available
- **Victorian Upgrade available** - Decorative posts can be fitted to create stylish structures that suit traditional surroundings.

Information on the design load and maximum span limits at specific locations in the UK can be accessed from the Customer Area of our website - please contact us for more details.



COLOURS AND FINISHES

The Simplicity Series

All Simplicity Series components and extrusions are supplied white as standard, but can be coloured to any RAL or BS paint code required.

We also offer a range of Designer Finishes including a stunning air brushed woodgrain effect, or even a marble finish for a truly unique structure. Please see our website for more information.



The Victorian Upgrade

All Simplicity Series canopies, carports and verandas can be fitted with our Victorian Upgrade to create an ornate and beautiful shade and shelter solution which will enhance the exterior of any building.



The Victorian Upgrade creates the ultimate high class finish to your canopy and is ideal for all home settings. It works brilliantly alongside buildings with historic/heritage features but can also offer a unique contrast for more modern styled buildings too.

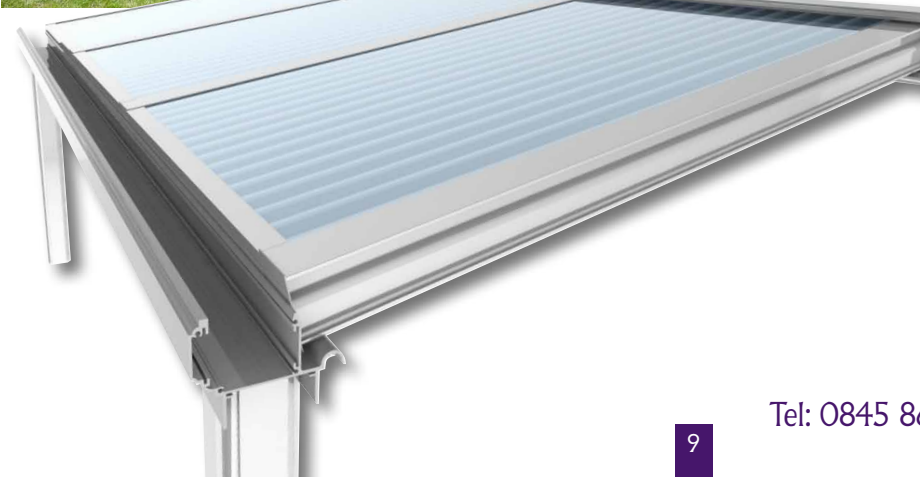

DOOR AND ENTRANCE CANOPIES

The Canofix System has a stunningly simple design that offers effortless installation due to the limited number of components required. Despite its simple design, a state-of-the-art rain dispersal system can easily be added to the canopy, as an optional extra, to effectively direct rainwater away from the canopy and prevent water dripping from the front of the canopy. An LED system can also be fitted to provide lighting under the canopy, which is ideal for residential and commercial buildings where easy access into buildings after dark may be required.

Canofix canopies are ideal for use as small entrance canopies, providing stylish cover at an unbelievably low cost. Due to the speed at which they can be installed and their low cost, these canopies are accessible to many smaller organisations that may not have a large budget to cover the expense of a larger canopy system. They are particularly popular with residential, commercial and industrial construction firms.

The system is installed with a single polycarbonate sheet to create seamless and neat cover, with no risk of leakage. With a curved, slim design these Canofix canopies can be installed to any length, with a projection of up to 1.5 metres.

No training is required for installing Canofix canopies due to the simplicity of installation.

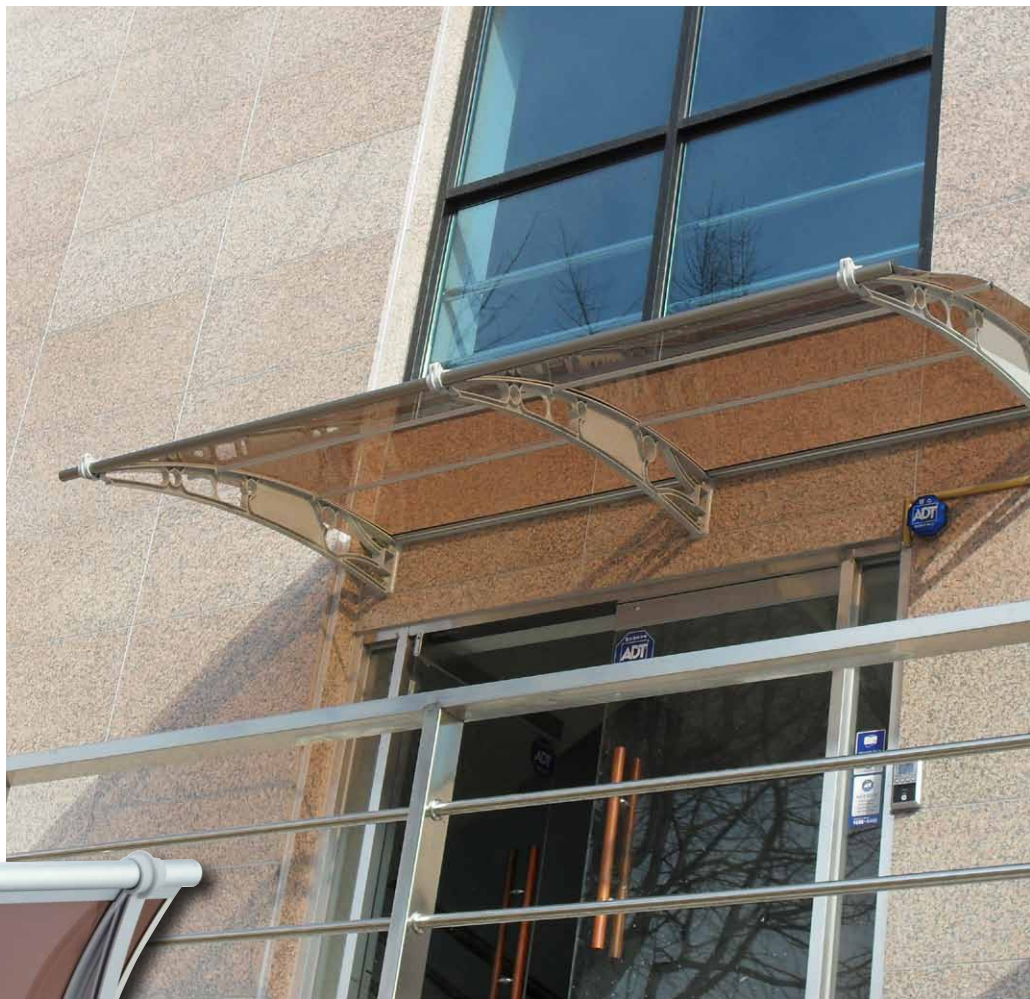



Features & Benefits

- Single polycarbonate roofing sheets create seamless and neat cover with no risk of leakage
- Can be installed to any length with a projection of up to 1.5m metres
- Easy and quick installation – no training required
- Stylish curved appearance.

Optional Extras

- Rain water dispersal system to prevent water dripping from the front of the canopy
- LED system available to provide under-canopy lighting.

Colour and Finishes

The polycarbonate roofing for Canofix canopies is available in Clear, Green, Blue, Brown or Grey. The brackets can be coloured to either Black or Silver.

**STUNNINGLY SIMPLE
DESIGN WITH
LIGHTNING FAST
INSTALLATION**

MILWOOD RAFTER GLAZING BAR

The Milwood Rafter Glazing Bar is a highly versatile aluminium component which can be used to create curved roofing systems. It is compatible with 5mm, 10mm, 16mm and 25mm polycarbonate, allowing you to offer a wide range of glazing options without the need for various sized rafter bars, saving on cost and storage space.

The Milwood Rafter Glazing Bar was specifically designed to take the hassle out of installing curved roof systems.

To ensure fitting this rafter bar is as simple as possible we adapted the shape of the bar to allow standard sized 5.5mm self drilling screws and self drilling tools to be used to secure the bar into place, which means no additional specialist tools are needed when installing this product.

Features & Benefits

- Can be secured into place with standard sized 5.5mm self drilling screws and self drilling tools (see Fig. 1)
- Unique internal clamp allows for additional clamping to mitigate wind uplift (shown in Fig. 2)
- Self supports up to 1.5m on a curved roof (shown in Fig. 3)
- Designed for use with 5mm, 10mm, 16mm and 25mm polycarbonate
- Aluminium glass stops included
- Dual gaskets for ultimate sealing.

CREATE STYLISH
CURVED
CANOPIES WITH
THE VERSATILE
MILWOOD RAFTER
GLAZING BAR

Fig. 1

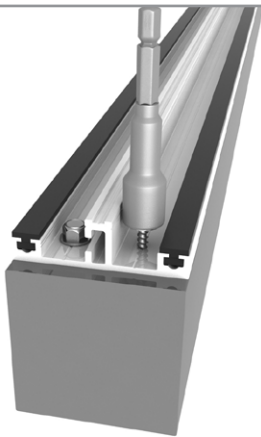

Fig. 2

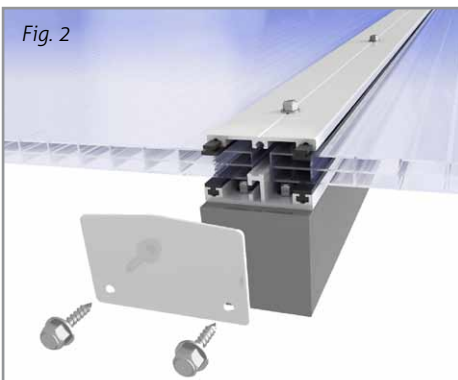
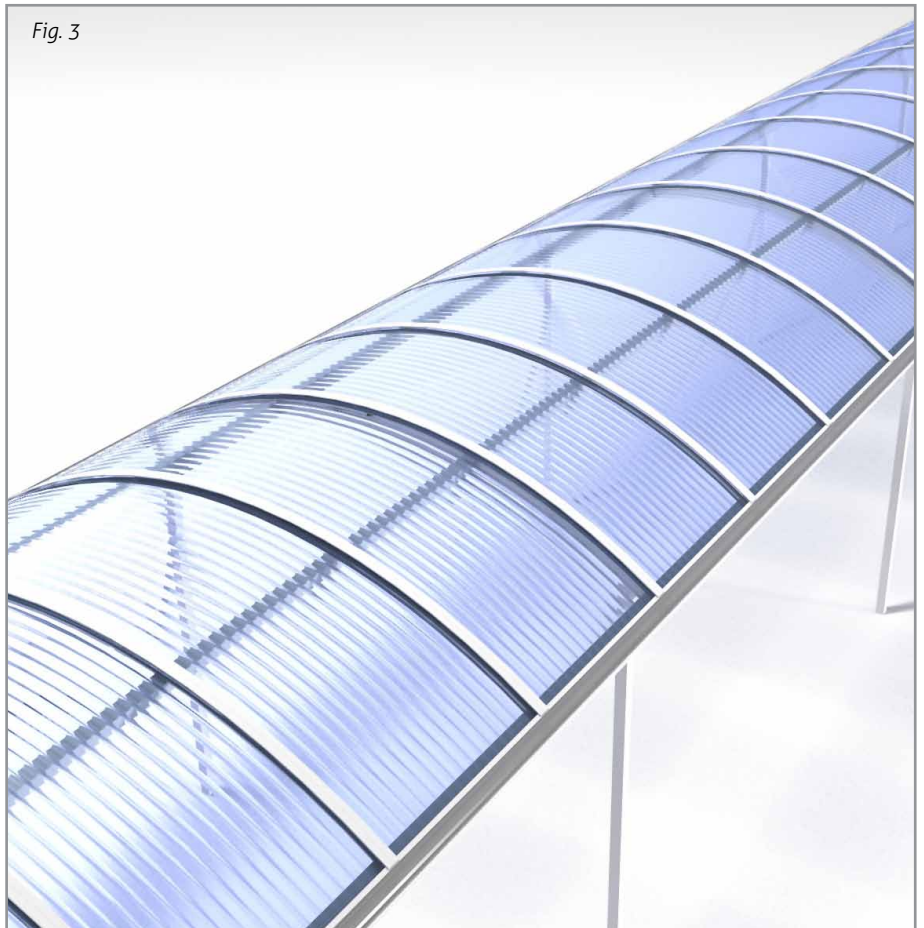
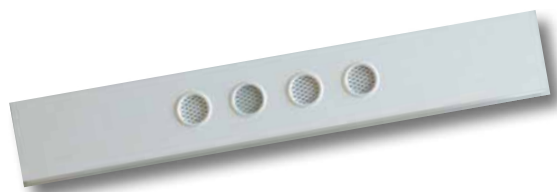

Fig. 3



AIR ACTIVE RIDGE VENT

The Air Active Ridge Vent has been designed to introduce a regulated air flow into conservatories, without comprising the conservatory's security. With its unique design, it can be used in any weather conditions, allowing the conservatory to stay fresh, whatever the weather.



Conservatories offer little ventilation, causing warm, damp air to build up, resulting in unsightly condensation and mould, which can damage furnishings and decor. Conventional roof vents are often used to provide a flow of air to prevent condensation, however these open air vents can compromise the security of the structure and often cannot be used in wet weather.

Unlike conventional vents, the Air Active Ridge Vent extracts humid air from the apex of the roof and this is then expelled through the glazing bar and exhausted

at the bar ends. Due to this revolutionary design the vent can be used in all weather conditions providing a comfortable environment all year round.

The Air Active Ridge Vent has an unobtrusive design which can be fitted to new and retro fit applications at an economical price. It has been specifically designed to be used with any structured sheet or glass units within a glazed roof system. The ventilator units are powered by a safe double insulated transformer providing safe extra low voltage to power the unit.

Features & Benefits

- Low cost installation and running costs
- Secure ventilation without the need for open roof vents or the opening of windows
- Hot, damp and stale air is easily removed from the structure
- A high rate of air extraction can be achieved – a unit removes up to 10,000 litres per hour of unwanted air
- Multiple electrical connection options are available including switch operated, timer operated, "plug and go", and thermostatic climate control unit.
- Extracts air only – does not let cold air in during the winter
- Can be retro fitted
- Reduces the risk of condensation
- Air movement is created even when outside conditions are still
- Tidy finish with supply cables hidden within the glazing bar system
- Available to fit to any panel width
- Easy installation
- Maintenance free.

Specifications:

Life Expectancy:	In excess of 30,000 hours of continuous running – equates to 10 years when running the unit for 8 hours a day
Running Cost	A pair of units is approximately £5.00 per year based on running the system for 2 hours per day
Electrical operation	Safe extra low voltage; double insulated transformers; thermally broken
Noise level	36 dBA at 1 metre from enclosed fan. (Measured in action in a conservatory with 32 dBA background noise)
Air change rate	Approx. 20 cubic metres per hour from a pair of units

OUR SERVICE

We pride ourselves on our exceptional service, and have developed long term relationships with many of our clients, which has resulted in them returning to us time and time again!

With stringently controlled Quality Management Systems and an exceptional work ethic, we offer a professional and friendly service that ensures all your requirements are catered for.

Our sales advisors are on hand to discuss your needs and ascertain the best option to meet your requirements and budget. We understand that our actions in turn impact on the quality of your service to

your customers and we always ensure our products are delivered to you in a timely manner and within agreed timescales.

Our sales team will also book in your training sessions, if required, when you order. These training sessions will be organised at a time to suit you; we advise these are organised on your first day of the scheduled installation.

OUR CUSTOMERS

Trade

We have vast experience in dealing with manufacturers of conservatory products and resellers of glazing systems and components. We continue to welcome new partners from these industries who wish to distribute and install our unique products; to become one of our valued partners please contact us today to arrange a meeting and we will show you the benefits of using cutting edge designs with simplicity that lasts.

Installers

Our kit form canopies, carports and veranda systems are designed with installation in mind and by taking advantage of our free Installation Training you will be able to fit our products quickly and easily, with no fuss. As part of our service we will deliver your kit, complete with DVD and training manual, directly to site.

Architects

We can provide detailed specifications for all our canopy, carport and veranda products including CAD drawings, photos and more. All information can be accessed online from our Customer Area – please contact us for more information.

Retailers

We are equipped to drop ship your products anywhere in the UK, fast and without fuss. Whatever the colour, size of order or location, you can be sure to receive the best service available. We can even brand our products with your logo to give maximum impact. Simply email a copy of your logo to us and we will take care of the rest.

All our customers receive access to the Customer Area of our website where you can download detailed product information and marketing literature to help you promote and sell our products with ease. For access to the Customer Area please email sales@milwoodgroup.com



DELIVERY INFORMATION

Our Manufacturing and Distribution Facility, centrally based in the heart of Leicestershire, allows us to deliver our systems to all areas of the UK within tight timescales.

We can deliver directly to site, and all kits come complete with fixings, silicon joining bars and every component required for a professional and successful installation.

Our lead times for delivery vary; please contact us for exact availability today.



HOW TO ORDER

We offer a range of ordering options designed to suit your individual needs.

0845 869 6006



Call us: Our dedicated sales advisors are on hand to discuss your requirements and guide you to the perfect solution for your needs.

sales@milwoodgroup.com



Email us: As soon as we receive your email enquiry we will work to fulfill your requirements.

www.milwoodgroup.com



Visit our website: View all the latest information on our company and our products. Many of our products are also available to purchase online, alternatively you can use our "Contact us" feature to get in touch and order a product.

Terms & Conditions

Pricing

Prices quoted are provisional and may be subject to change without prior notice. Prices exclude VAT.

Carriage

All prices are supplied based on Ex-Works delivery. Delivery to a specific location will incur an additional charge. Please check with our sales staff for availability of stock and our current delivery capabilities.

Payment

Approved accounts will be invoiced; payment terms are strictly 30 days from invoice. Payment by non-approved accounts may be made by cheque, with goods dispatched when the cheque has cleared. Please note: this may delay dispatch of goods by up to seven working days. Payment for online orders can be made by credit or debit card, or via PayPal.

For full terms & conditions please visit our website: www.milwoodgroup.com



World Class Trade Glazing Systems Delivered Fast



Head office: Ashford House, 173 Ashford Road
Bearsted, Maidstone, Kent ME14 4NE

0845 869 6006
sales@milwoodgroup.com
www.milwoodgroup.com