

FRONT VIEW & ROOF TOP VIEW WITH BUILDING

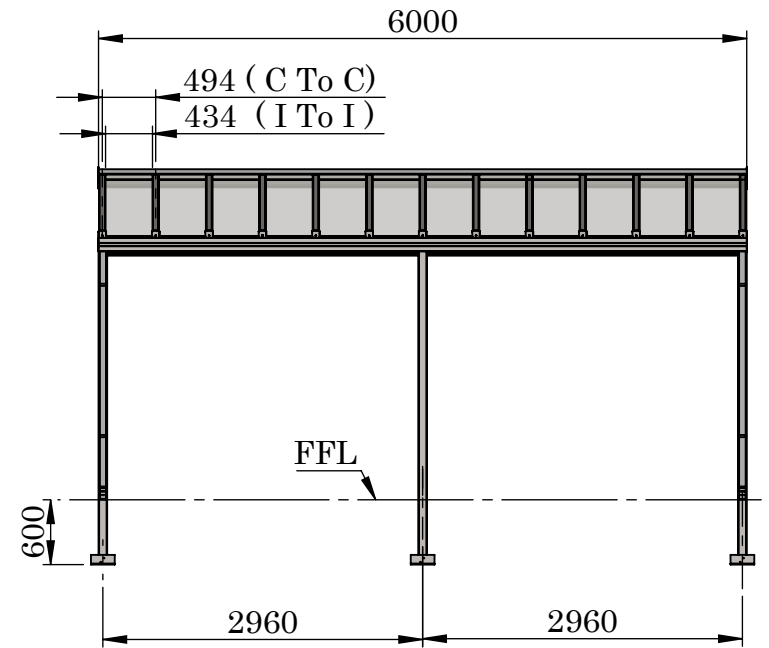
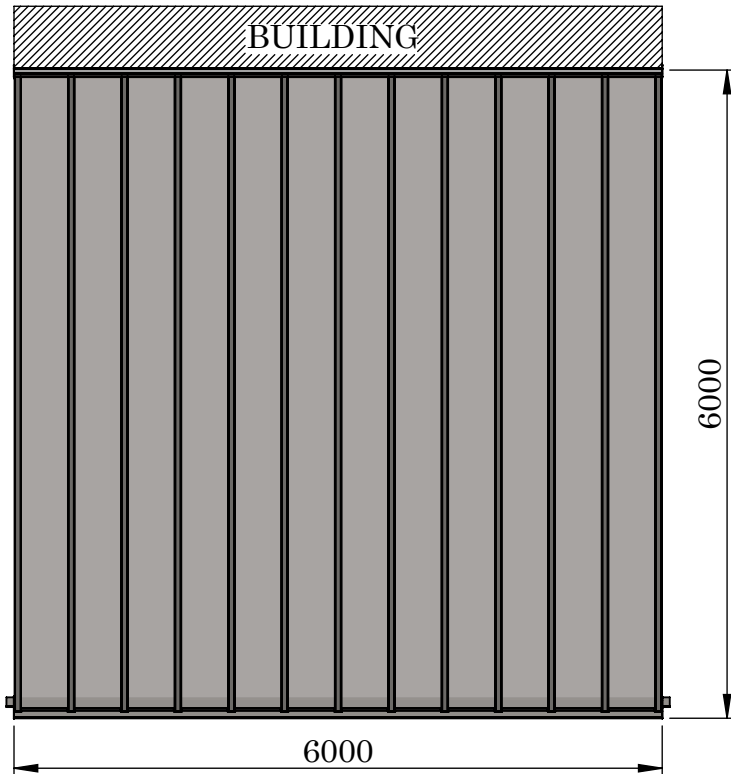

Poly : Opal Polycarbonate Roof Panels.

Total Weight : 465.86 KG.

Aluminium Weight : 331.92KG.

Poly Weight : 133.93 KG.

Attention: This is a CAD drawing for reference only.
For Installation Instructions, please refer to the install guide.

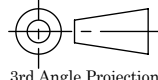
RAL Code	RAL 9016 White Textured	Warehouse	Drawing Title : Cambridge Canopies Ltd						
Colour & Finish of Canopy			Product Name : Simplicity 35						
System Delivery Address		Checked By :	Customer Sign :	 3rd Angle Projection	Page	Date	Page Size	Scale	Drawn
Post Code :			Order No. :		1 OF 7	10/05/23	A4 (L)	NTS	MK
Post Code for installation :	Delivery Date :		Finish	Issuer	(Tol) +/-	Sequence	Revision		
			PPC	ACS	1 mm	000001	V1.1		

CROSS SECTION VIEW & ISOMETRIC VIEW

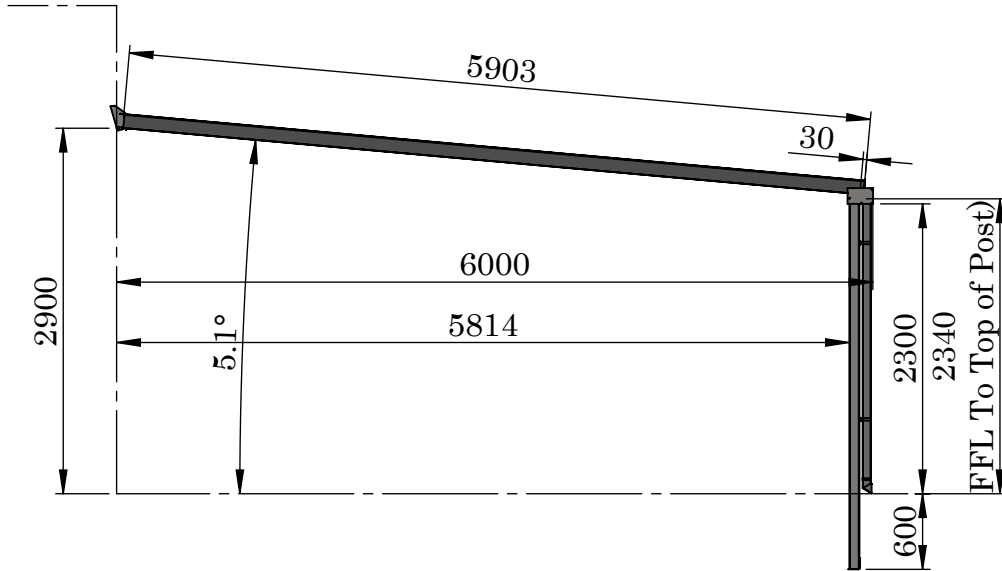
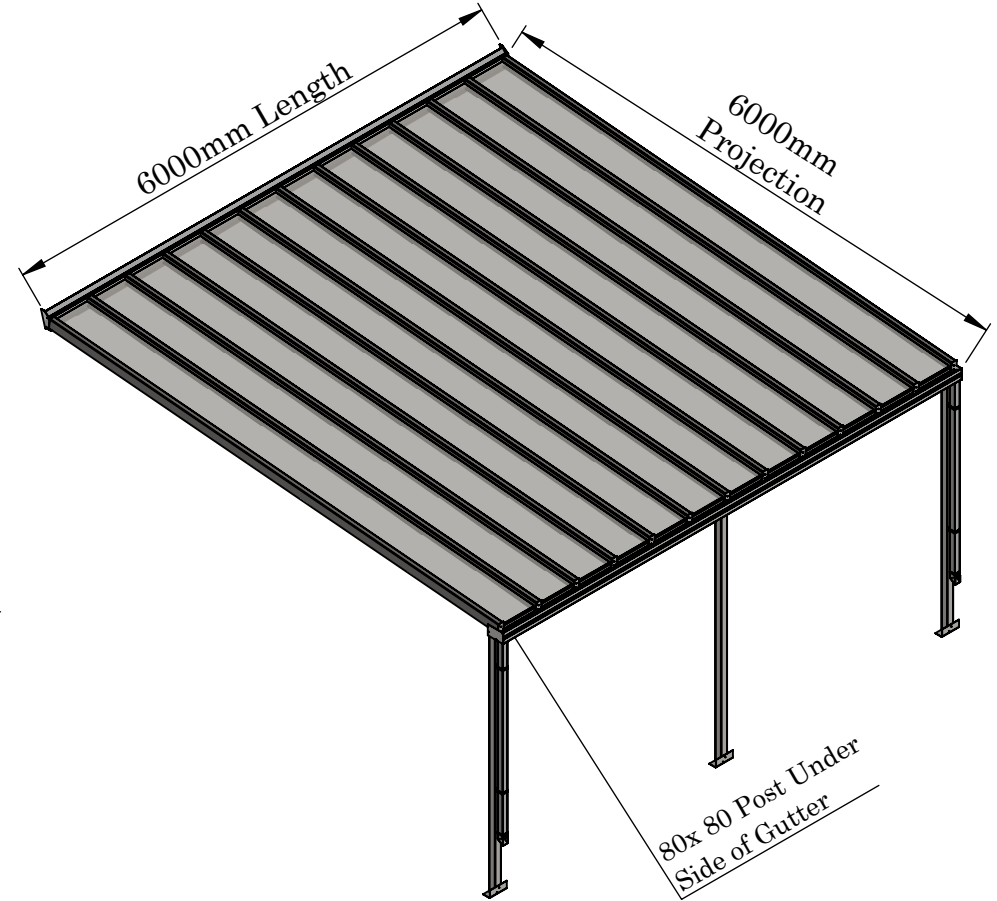
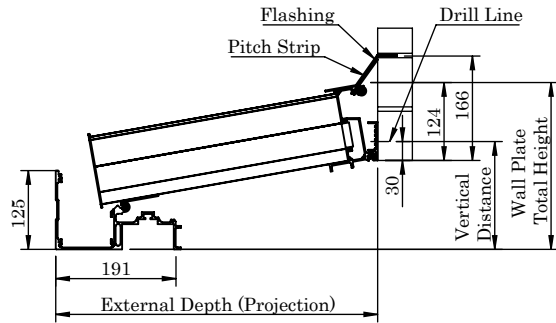

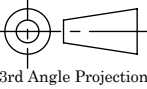
RAL Code	RAL 9016 White Textured	Warehouse	Drawing Title : Cambridge Canopies Ltd						
Colour & Finish of Canopy			Product Name : Simplicity 35						
System Delivery Address		Checked By :	Customer Sign :	 3rd Angle Projection	Page 2 OF 7	Date 10/05/23	Page Size A4 (L)	Scale NTS	Drawn MK
Post Code :			Order No. :		Finish PPC	Issuer ACS	(Tol) +/- 1 mm	Sequence 000001	Revision V1.1
Post Code for installation :	Delivery Date :								

PRODUCT DETAIL

Wall Plate & Roof Bar Section

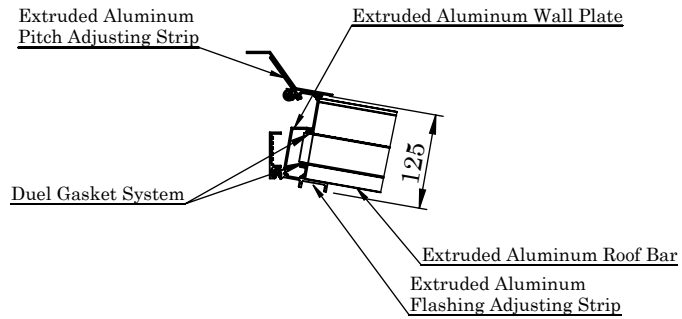

Roof Bar & Sheet Section

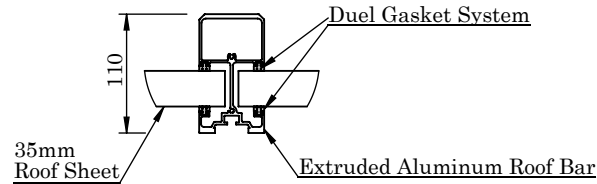

Base & Post Connection Information

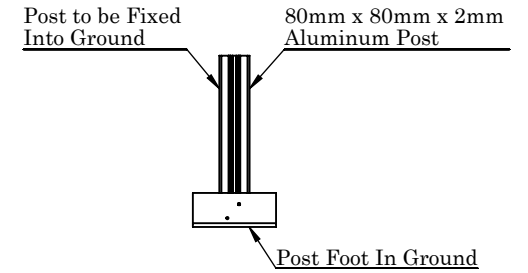

Eaves Beam Roof Bar & Post Section

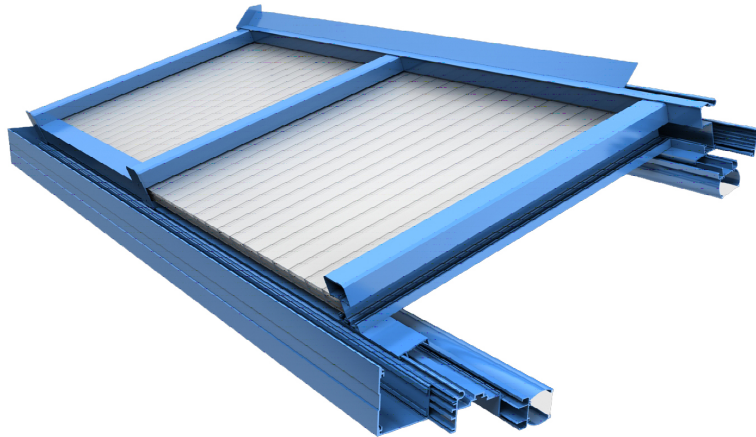
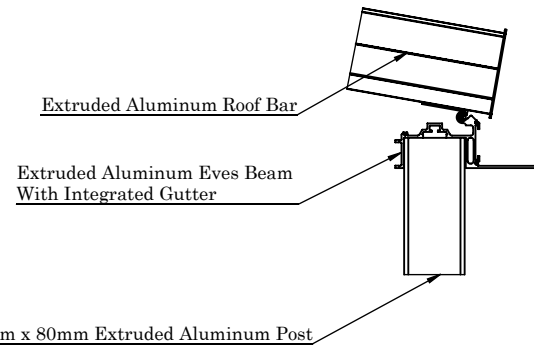

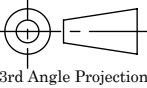
RAL Code	RAL 9016 White Textured	Warehouse	Drawing Title : Cambridge Canopies Ltd						
Colour & Finish of Canopy			Product Name : Simplicity 35						
System Delivery Address		Checked By :	Customer Sign :	 3rd Angle Projection	Page	Date	Page Size	Scale	Drawn
Post Code :			Order No. :		Finish	3 OF 7	10/05/23	A4 (L)	NTS
Post Code for installation :	Delivery Date :			PPC	Issuer	(Tol) +/- 1 mm	Sequence	Revision	
				ACS		000001	V1.1		

POLY DETAIL

Poly Type	35mm Opal Poly
No. Of Poly Pannel	12
Poly m ²	34.34 m ²

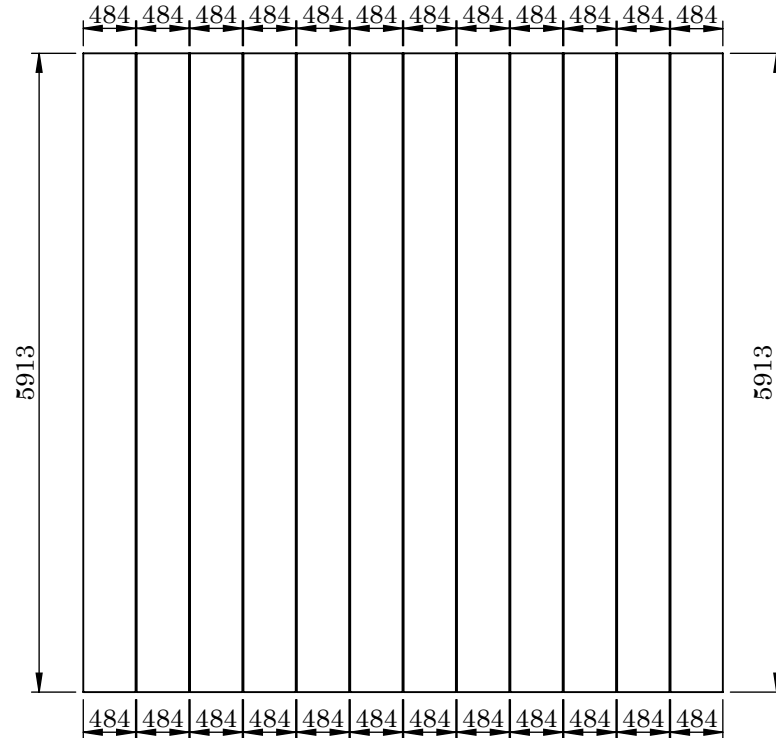

POLY SIZE

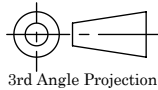
RAL Code	RAL 9016 White Textured	Warehouse	Drawing Title : Cambridge Canopies Ltd						
Colour & Finish of Canopy			Product Name : Simplicity 35						
System Delivery Address		Checked By :	Customer Sign :	 3rd Angle Projection	Page	Date	Page Size	Scale	Drawn
Post Code :			Order No. :		7 OF 7	10/05/23	A4 (L)	NTS	MK
Post Code for installation :			Delivery Date :		Finish	Issuer	(Tol) +/-	Sequence	Revision
			PPC	ACS	1 mm	000001	V1.1		