

FRONT VIEW & ROOF TOP VIEW WITH BUILDING

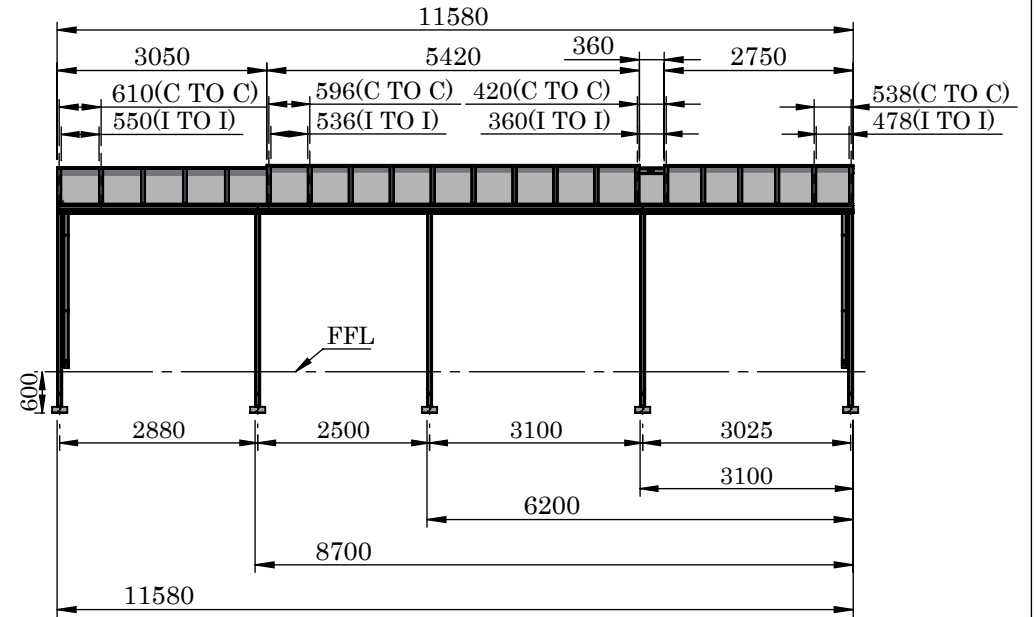
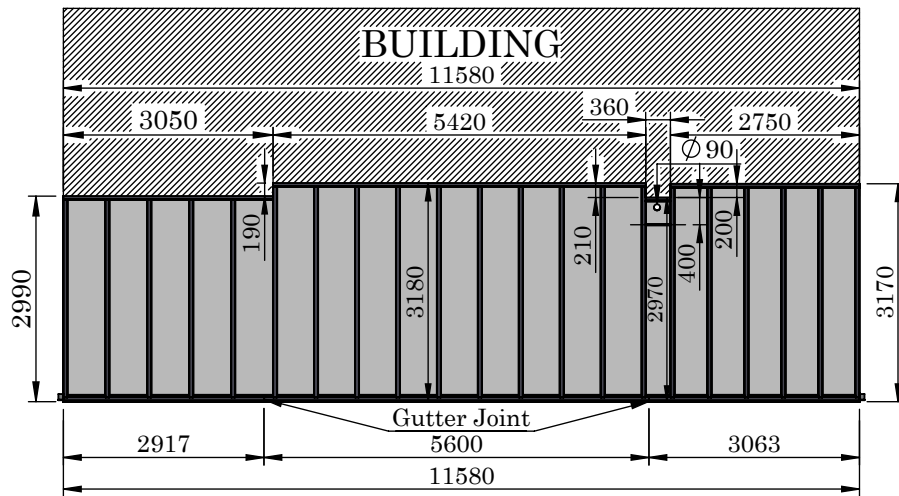

Glass : 6mm Clear Glass Roof Panels.

Total Weight : 749.56 KG.

Glass Weight : 512.51 KG.

Aluminium Weight : 237.04 KG.

Attention: This is a CAD drawing for reference only.
For Installation instructions, please refer to the install guide.

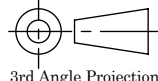
RAL Code	RAL 7016 Anthracite Grey (Textured)	Warehouse	Drawing Title : Zenith CSL						
Colour & Finish of Canopy			Product Name : Simplicity 6						
System Delivery Address		Checked By :	Customer Sign :	 3rd Angle Projection	Page	Date	Page Size	Scale	Drawn
Post Code :			Order No. :		1 OF 8	11/01/23	A4 (L)	NTS	VA
Post Code for installation :	Delivery Date :		Finish	Issuer	(Tol) +/-	Sequence	Revision		
			PPC	ACS	1 mm	000001	V1.2		

CROSS SECTION VIEW & ISOMETRIC VIEW

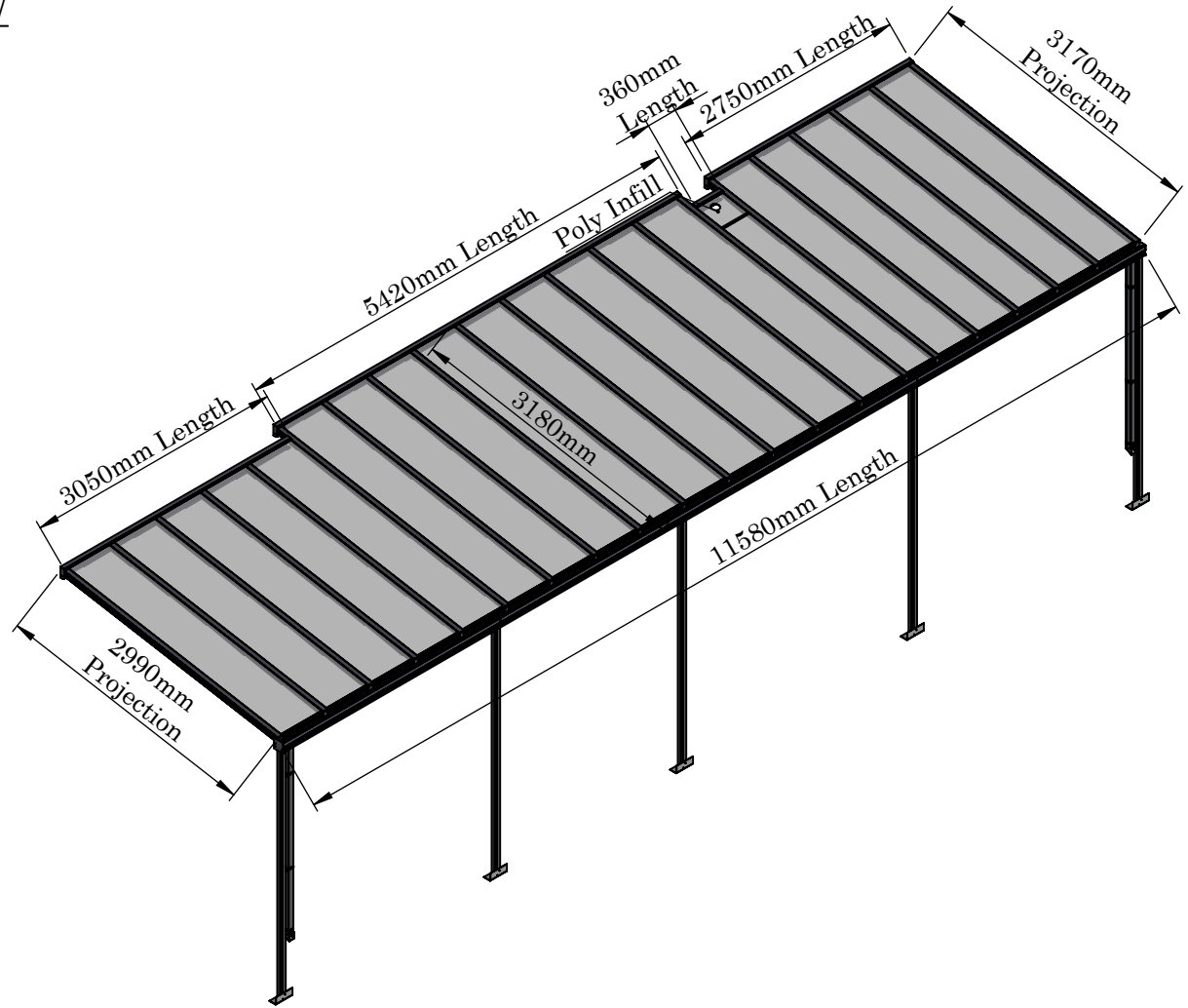
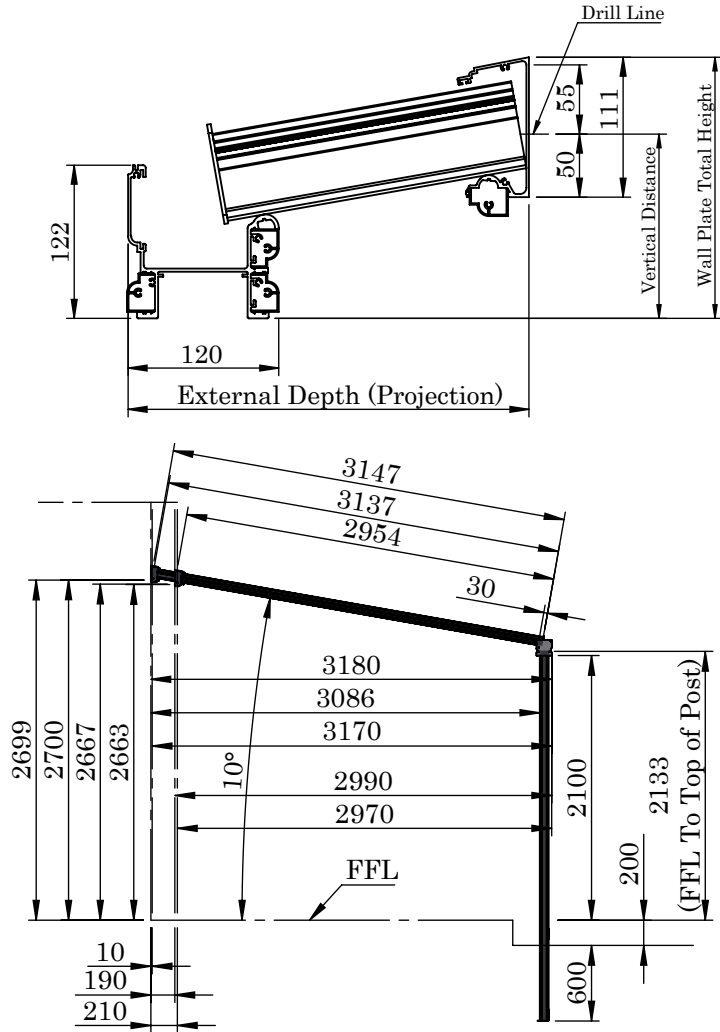

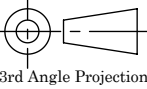
RAL Code	RAL 7016 Anthracite Grey (Textured)	Warehouse	Drawing Title : Zenith CSL						
Colour & Finish of Canopy			Product Name : Simplicity 6						
System Delivery Address	Delivery Date :	Checked By :	Customer Sign :	 3rd Angle Projection	Page	Date	Page Size	Scale	Drawn
Post Code :		Order No. :	Finish		Issuer	(Tol) +/-	Sequence	Revision	
Post Code for installation :		Delivery Date :	PPC	ACS	1 mm	000001	V1.2		

PRODUCT DETAIL

Wall Plate & Roof Bar Section

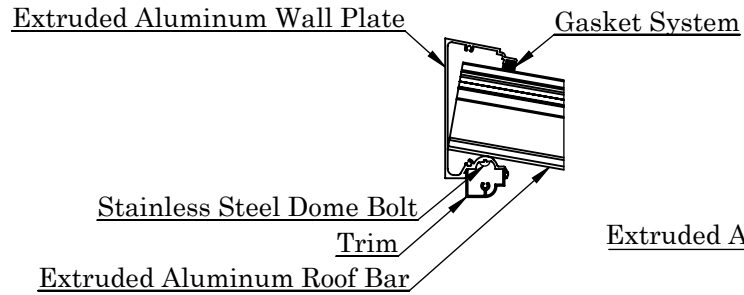

Roof Bar & Sheet Section

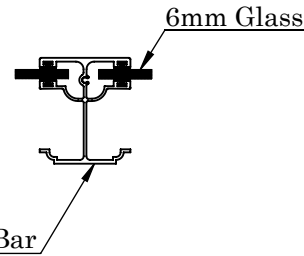

Base & Post Connection Information

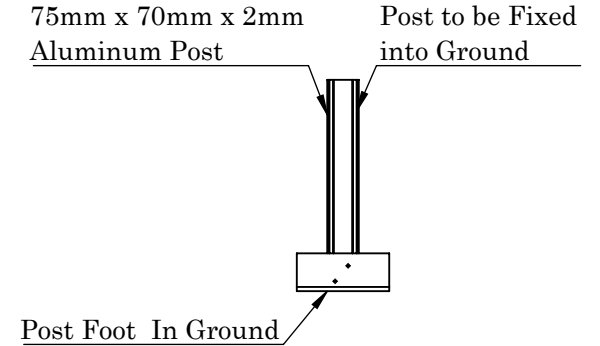

Eaves Beam Roof Bar & Post Section

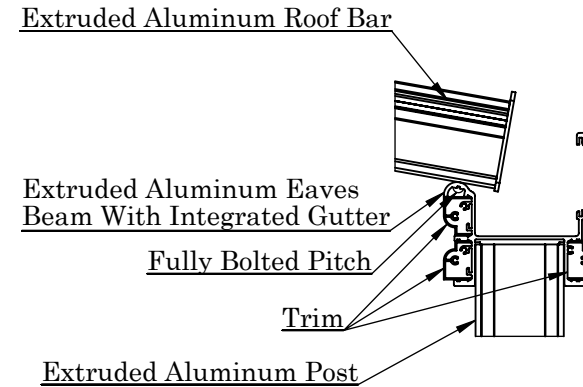

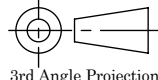
RAL Code	RAL 7016 Anthracite Grey (Textured)	Warehouse	Drawing Title : Zenith CSL						
Colour & Finish of Canopy			Product Name : Simplicity 6						
System Delivery Address		Checked By :	Customer Sign :	 3rd Angle Projection	Page	Date	Page Size	Scale	Drawn
Post Code :			Order No. :		Finish	Issuer	(Tol) +/-	Sequence	Revision
Post Code for installation :	Delivery Date :		PPC	ACS	1 mm	000001	V1.2		

ITEM NO.	Simplicity 6 RAL 7016 Anthracite Grey (Textured)					Items Cut/Pack	Quality Checked	Packed & Ready for Dispatch
	PRODUCT CODE	DESCRIPTION	QTY.	LENGTH	Size Checked			
CUTTING LIST - Simplicity 6 System RAL 7016 Anthracite Grey (Textured)								
1a	RAL7016 Anthracite Grey Sim 6 Main Bar (FTX)	RAL7016 Anthracite Grey Sim 6 Main Bar (FTX)	4	2954mm				
1b	RAL7016 Anthracite Grey Sim 6 Main Bar (FTX)	RAL7016 Anthracite Grey Sim 6 Main Bar (FTX)	10	3147mm				
1c	RAL7016 Anthracite Grey Sim 6 Main Bar (FTX)	RAL7016 Anthracite Grey Sim 6 Main Bar (FTX)	5	3137mm				
2	RAL7016 Anthracite Grey Sim 6 Lens Glazing Bar (FTX)	RAL7016 Anthracite Grey Sim 6 Lens Glazing Bar (FTX)	0					
3	Plastic Lens for Glazing Bar	Plastic Lens for Glazing Bar 8MM	0					
4a	RAL7016 Anthracite Grey Sim 6 End Bar (FTX)	RAL7016 Anthracite Grey Sim 6 End Bar (FTX)	1	2954mm				
4b	RAL7016 Anthracite Grey Sim 6 End Bar (FTX)	RAL7016 Anthracite Grey Sim 6 End Bar (FTX)	1	3137mm				
5a	RAL7016 Anthracite Grey Sim 6 & 16 Wall Plate (FTX)	RAL7016 Anthracite Grey Sim 6 & 16 Wall Plate (FTX)	1	3050mm				
5b	RAL7016 Anthracite Grey Sim 6 & 16 Wall Plate (FTX)	RAL7016 Anthracite Grey Sim 6 & 16 Wall Plate (FTX)	1	5420mm				
5c	RAL7016 Anthracite Grey Sim 6 & 16 Wall Plate (FTX)	RAL7016 Anthracite Grey Sim 6 & 16 Wall Plate (FTX)	1	360mm				
5d	RAL7016 Anthracite Grey Sim 6 & 16 Wall Plate (FTX)	RAL7016 Anthracite Grey Sim 6 & 16 Wall Plate (FTX)	1	2750mm				
6a	RAL7016 Anthracite Grey Sim 6 & 16 Gutter (FTX)	RAL7016 Anthracite Grey Sim 6 & 16 Gutter (FTX)	1	2917mm				
6b	RAL7016 Anthracite Grey Sim 6 & 16 Gutter (FTX)	RAL7016 Anthracite Grey Sim 6 & 16 Gutter (FTX)	1	5600mm				
6c	RAL7016 Anthracite Grey Sim 6 & 16 Gutter (FTX)	RAL7016 Anthracite Grey Sim 6 & 16 Gutter (FTX)	1	3063mm				
7a	RAL7016 Anthracite Grey Sim 6 Gutter & Wall Plate Trim (FTX)	RAL7016 Anthracite Grey Sim 6 Gutter & Wall Plate Trim (FTX)	1	3050mm				
7b	RAL7016 Anthracite Grey Sim 6 Gutter & Wall Plate Trim (FTX)	RAL7016 Anthracite Grey Sim 6 Gutter & Wall Plate Trim (FTX)	1	5420mm				
7c	RAL7016 Anthracite Grey Sim 6 Gutter & Wall Plate Trim (FTX)	RAL7016 Anthracite Grey Sim 6 Gutter & Wall Plate Trim (FTX)	1	360mm				
7d	RAL7016 Anthracite Grey Sim 6 Gutter & Wall Plate Trim (FTX)	RAL7016 Anthracite Grey Sim 6 Gutter & Wall Plate Trim (FTX)	1	2750mm				
7e	RAL7016 Anthracite Grey Sim 6 Gutter & Wall Plate Trim (FTX)	RAL7016 Anthracite Grey Sim 6 Gutter & Wall Plate Trim (FTX)	3	6000mm				
7f	RAL7016 Anthracite Grey Sim 6 Gutter & Wall Plate Trim (FTX)	RAL7016 Anthracite Grey Sim 6 Gutter & Wall Plate Trim (FTX)	3	5580mm				
8a	RAL7016 Anthracite Grey Sim 6 F Section 6mm (FTX)	RAL7016 Anthracite Grey Sim 6 F Section 6mm (FTX)	5	550mm				
8b	RAL7016 Anthracite Grey Sim 6 F Section 6mm (FTX)	RAL7016 Anthracite Grey Sim 6 F Section 6mm (FTX)	9	536mm				
8c	RAL7016 Anthracite Grey Sim 6 F Section 6mm (FTX)	RAL7016 Anthracite Grey Sim 6 F Section 6mm (FTX)	1	360mm				
8d	RAL7016 Anthracite Grey Sim 6 F Section 6mm (FTX)	RAL7016 Anthracite Grey Sim 6 F Section 6mm (FTX)	5	478mm				

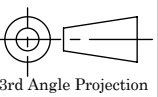
RAL Code	RAL 7016 Anthracite Grey (Textured)	Warehouse	Customer Reference : PO6551 - Jackie Grieve	Drawing Title : Zenith CSL					
Colour & Finish of Canopy			Customer Sign :	Product Name : Simplicity 6					
System Delivery Address	Unit 1-3 Stokes Farm Binfield Road Wokingham Berkshire	Checked By :	Order No. :		Page 4 OF 8	Date 11/01/23	Page Size A4 (L)	Scale NTS	Drawn VA
Post Code : RG40 5PR				Delivery Date :	Finish PPC	Issuer ACS	(Tol) +/- 1 mm	Sequence 000001	Revision V1.2

ITEM NO.	PRODUCT CODE	DESCRIPTION	QTY.	LENGTH	Size Checked	Items Cut/Pack	Quality Checked	Packed & Ready for Dispatch
9	RAL7016 Anthracite Grey Sim 6 & 16 Standard Post (FTX)	RAL7016 Anthracite Grey Sim 6 & 16 Standard Post (FTX)	5	3000mm				
10	RAL7016 Anthracite Grey Sim 6 & 16 Square Posts (FTX)	RAL7016 Anthracite Grey Sim 6 & 16 Square Posts (FTX)	0					
11	RAL7016 Anthracite Grey Simplicity Xtra Post (FTX)	RAL7016 Anthracite Grey Simplicity Xtra Post (FTX)	0					
12	S6/WPG	Sim 6 Wall Plate Gasket	1	11580mm				
13a	SPP2337	Sim 6 Glazing Bar Top Gasket	9	2954mm				
13b	SPP2401	Sim 6 Glazing Bar Bottom Gasket	9	2954mm				
14a	SPP2337	Sim 6 Glazing Bar Top Gasket	20	3147mm				
14b	SPP2401	Sim 6 Glazing Bar Bottom Gasket	20	3147mm				
15a	SPP2337	Sim 6 Glazing Bar Top Gasket	11	3137mm				
15b	SPP2401	Sim 6 Glazing Bar Bottom Gasket	11	3137mm				
16a	RAL7016 Anthracite Grey Sim 6 Gutter Infill (FTX)	RAL7016 Anthracite Grey Sim 6 Gutter Infill (FTX)	1	2803mm				
16b	RAL7016 Anthracite Grey Sim 6 Gutter Infill (FTX)	RAL7016 Anthracite Grey Sim 6 Gutter Infill (FTX)	1	2423mm				
16c	RAL7016 Anthracite Grey Sim 6 Gutter Infill (FTX)	RAL7016 Anthracite Grey Sim 6 Gutter Infill (FTX)	1	3023mm				
16d	RAL7016 Anthracite Grey Sim 6 Gutter Infill (FTX)	RAL7016 Anthracite Grey Sim 6 Gutter Infill (FTX)	1	2948mm				
17	Drainage/DPBlack	Black Square Downpipe 5.5m	2	2750mm				
18	Drainage/40mm/Pipe	40mm Internal Kit Down Pipe 3m	0					

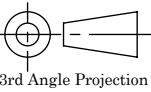
RAL Code		RAL 7016 Anthracite Grey (Textured)		Warehouse	Customer Reference : PO6551 - Jackie Grieve		Drawing Title : Zenith CSL					
Colour & Finish of Canopy					Product Name : Simplicity 6							
System Delivery Address		Unit 1-3 Stokes Farm Binfield Road Wokingham Berkshire		Checked By :	Customer Sign :		 3rd Angle Projection	Page	Date	Page Size	Scale	Drawn
Post Code : RG40 5PR					Order No. :			5 OF 8	11/01/23	A4 (L)	NTS	VA
Post Code for installation :		Delivery Date :				Finish	Issuer	(Tol) +/-	Sequence	Revision		
						PPC	ACS	1 mm	000001	V1.2		

ITEM NO.	PRODUCT CODE	DESCRIPTION	QTY.	LENGTH	Size Checked	Items Cut/Pack	Quality Checked	Packed & Ready for Dispatch
FIXTURES LIST - SIM 6 COMPONENTS								
19	Fastener 51	M5 Black Domed Hex Head Cap	147					
20	Fastener 13	no 10 x 1 hex self tapper ab zp din.7976c zinc plated	52					
21	Fastener 25	M6 X 20MM SS pan/pozi screws a4	101					
22	Fastener 04	No12 x Self Driller 1/1.4	95					
23	Fastener 05	M6 NYLOC INSERT NUT ST/ST A4	101					
END PLATES LIST - SIM 6 COMPONENTS								
24	RAL7016 Anthracite Grey Sim 6 & 16 Main Bar End Plates (FTX)	RAL7016 Anthracite Grey Sim 6 & 16 Main Bar End Plates (FTX)	19					
25	RAL7016 Anthracite Grey Sim 6 Bar End Plate Off Set Hole (FTX)	RAL7016 Anthracite Grey Sim 6 Bar End Plate Off Set Hole (FTX)	2					
26	RAL7016 Anthracite Grey Sim 6 Wall Plate End Plate (FTX)	RAL7016 Anthracite Grey Sim 6 Wall Plate End Plate (FTX)	8					
27	RAL7016 Anthracite Grey Sim 6 Gutter End Plate (FTX)	RAL7016 Anthracite Grey Sim 6 Gutter End Plate (FTX)	2					
28	RAL7016 Anthracite Grey Sim Xtra Post End Plate (FTX)	RAL7016 Anthracite Grey Sim Xtra Post End Plate (FTX)	0					
VICTORIAN UPGRADES - SIM 6 COMPONENTS								
29	RAL7016 Anthracite Grey Victorian Base Casting 6 & 16 (FTX)	RAL7016 Anthracite Grey Victorian Base Casting 6 & 16 (FTX)	0					
30	RAL7016 Anthracite Grey Gallows Brackets 300mm x 300mm (FTX)	RAL7016 Anthracite Grey Gallows Brackets 300mm x 300mm (FTX)	0					
DRAINAGE LIST - SIM 6 COMPONENTS								
31	Drainage/DPSBlack	Black Down Pipe Shoe	2					
32	Drainage/SFPCBlack	Single Fix Square Downpipe Clip Black	4					
33	Drainage/DPBBlack	Black Square Bend 90 degrees	0					
34	Drainage/DPSBend112B	112 Degree Square Downpipe Bend Black	0					
35	Drainage/40mm/Bend	40mm Internal Kit Swivel Bend	0					
36	Drainage/40mm/Joiner	40mm Internal Kit Straight Joiner	0					
37	Drainage/Spigot	Downpipe Spigot	2					

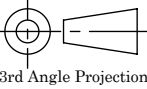
RAL Code	RAL 7016 Anthracite Grey (Textured)	Warehouse	Customer Reference : PO6551 - Jackie Grieve	Drawing Title : Zenith CSL					
Colour & Finish of Canopy			Customer Sign :	Product Name : Simplicity 6					
System Delivery Address	Unit 1-3 Stokes Farm Binfield Road Wokingham Berkshire	Checked By :	Order No. :	 3rd Angle Projection	Page 6 OF 8	Date 11/01/23	Page Size A4 (L)	Scale NTS	Drawn VA
Post Code : RG40 5PR					Finish PPC	Issuer ACS	(Tol) +/- 1 mm	Sequence 000001	Revision V1.2
Post Code for installation :	Delivery Date :								

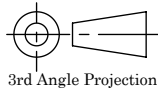
ITEM NO.	PRODUCT CODE	DESCRIPTION	QTY.	LENGTH	Size Checked	Items Cut/Pack	Quality Checked	Packed & Ready for Dispatch			
JOINERS - SIM 6 COMPONENTS											
38	S6&16/EAJoiner1	Sim 6 & 16 18 x 300 Gutter Joiner	4								
39	S6&16/EAJoiner2	Sim 6 & 16 61.5 x 300 Gutter Joiner 2	2								
40	RAL7016 Anthracite Grey Sim 6 & 16 70 x 300 Gutter Joiner 3 (FTX)	RAL7016 Anthracite Grey Sim 6 & 16 70 x 300 Gutter Joiner 3 (FTX)	2								
GLASS JOINERS - SIM 6 COMPONENTS											
41	S6/PlasticJoinerB	Black Plastic Joiner	1								
42	S6/PolyInfill	6mm Solid Clear Infill 600mm x 400mm	1	600x400mm							
POST BRACKETS - SIM 6 COMPONENTS											
43	Generic In Ground Post Bracket	Generic In Ground Post Bracket	5								
44	RAL7016 Anthracite Grey Sim 6 & 16 Bolt To Ground Post Bracket (FTX)	RAL7016 Anthracite Grey Sim 6 & 16 Bolt To Ground Post Bracket (FTX)	0								
45	RAL7016 Anthracite Grey Sim Xtra Bolt To Ground Bracket (FTX)	RAL7016 Anthracite Grey Sim Xtra Bolt To Ground Bracket (FTX)	0								
SILICONE & SPRAY CANS - SIM 6 COMPONENTS											
46	Silicone/SILC/002	Soudall Black	2								
47	Spray/7016	Spray Can RAL7016 Anthracite Grey Textured	2								
GLASS											
48	Glass/6MMACCLEAR	6mm Self Cleaning Activ Clear Glass	0								
49	Glass/6MMACBLUE	6mm Self Cleaning Activ Blue Glass	0								
50	Glass/6MMECCBLUE	6mm Easy Clean Blue Glass - Self-Cleaning	0								
51	Glass/6MMBLUE	6mm Blue Tinted Glass	0								
52	Glass/6MMBRONZE	6mm Bronze Tinted Glass	0								
53	Glass/6MMGREEN	6mm Green Tinted Glass	0								
54	Glass/6MMGREY	6mm Grey Tinted Glass	0								
55	Glass/6MMTOUGH	6mm Clear Glass	5	Length-2954mm x Width-590mm							
56	Glass/6MMTOUGH	6mm Clear Glass	9	Length-3147mm x Width-576mm							
57	Glass/6MMTOUGH	6mm Clear Glass	1	Length-2537mm x Width-400mm							
58	Glass/6MMTOUGH	6mm Clear Glass	5	Length-3137mm x Width-518mm							
RAL Code		RAL 7016 Anthracite Grey (Textured)	Warehouse	Customer Reference : PO6551 - Jackie Grieve		Drawing Title : Zenith CSL					
Colour & Finish of Canopy						Product Name : Simplicity 6					
System Delivery Address		Unit 1-3 Stokes Farm Binfield Road Wokingham Berkshire	Checked By :	Customer Sign :		 3rd Angle Projection	Page	Date	Page Size	Scale	Drawn
Post Code : RG40 5PR				Order No. :			7 OF 8	11/01/23	A4 (L)	NTS	VA
Post Code for installation :		Delivery Date :		Finish	Issuer	(Tol) +/-	Sequence	Revision			
				PPC	ACS	1 mm	000001	V1.2			

Glass Detail

Glass Type	6mm Clear Glass
No Of Glass Panel	20
Glass m ²	34.16 m ²

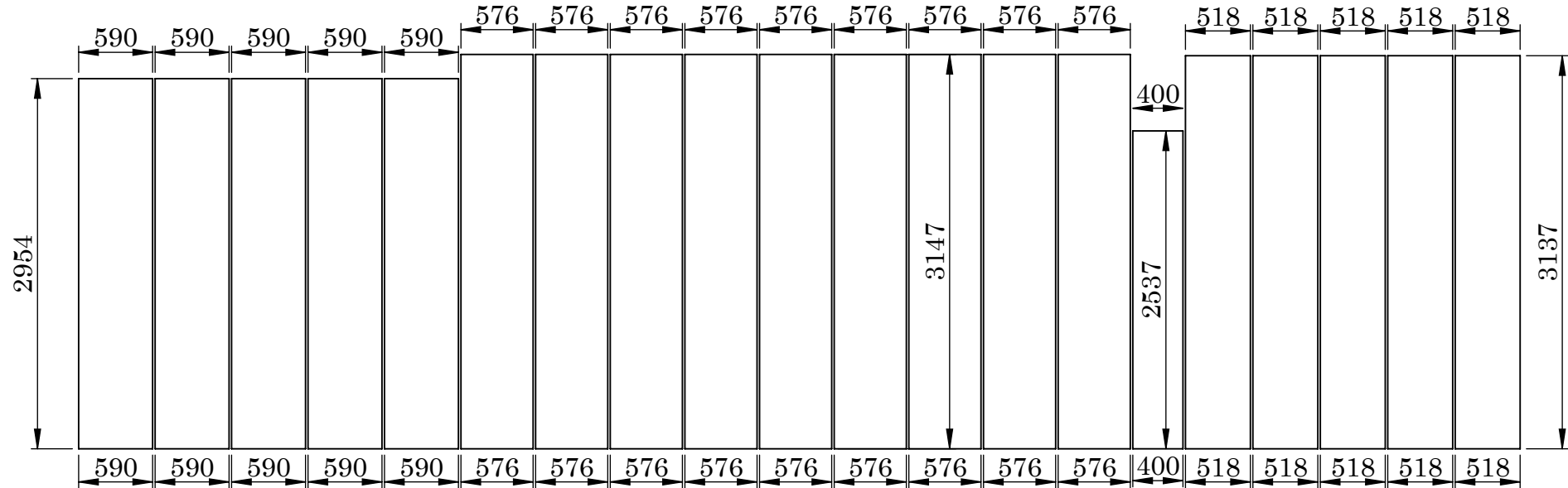

GLASS SIZE

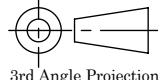
RAL Code	RAL 7016 Anthracite Grey (Textured)	Warehouse	Drawing Title : Zenith CSL						
Colour & Finish of Canopy			Product Name : Simplicity 6						
System Delivery Address		Checked By :	Customer Sign :	 3rd Angle Projection	Page	Date	Page Size	Scale	Drawn
Post Code :			Order No. :		8 OF 8	11/01/23	A4 (L)	NTS	VA
Post Code for installation :			Delivery Date :	Finish	Issuer	(Tol) +/-	Sequence	Revision	
			PPC	ACS	1 mm	000001	V1.2		